

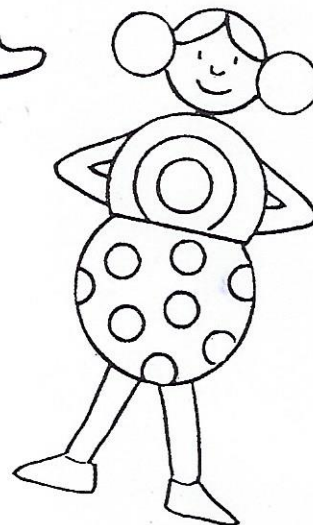

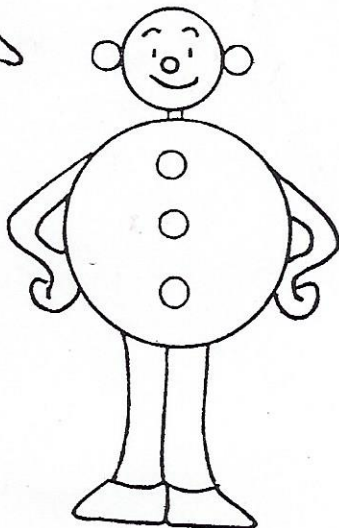

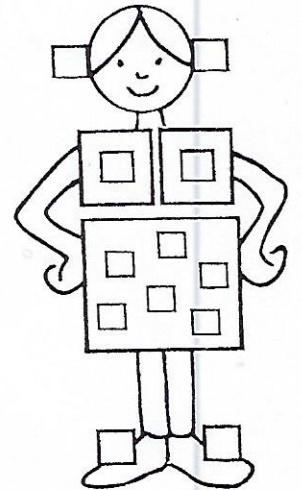

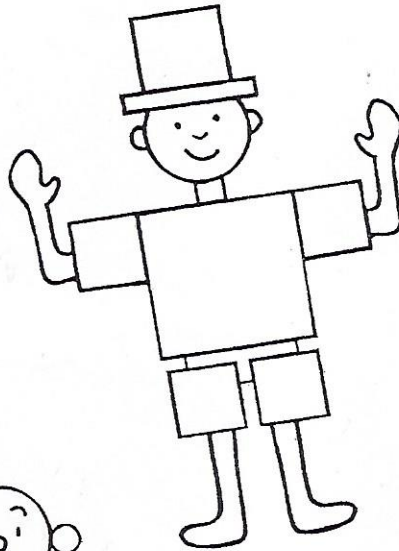

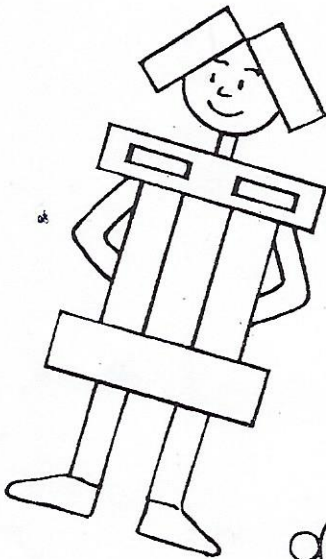
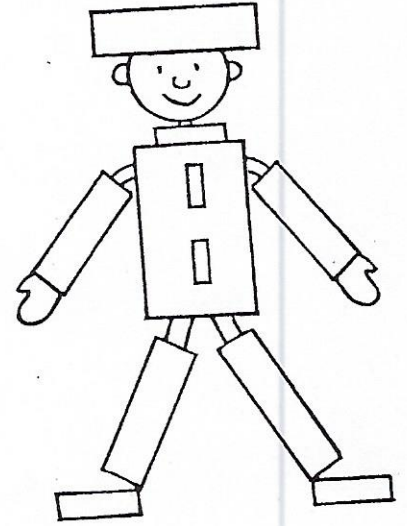
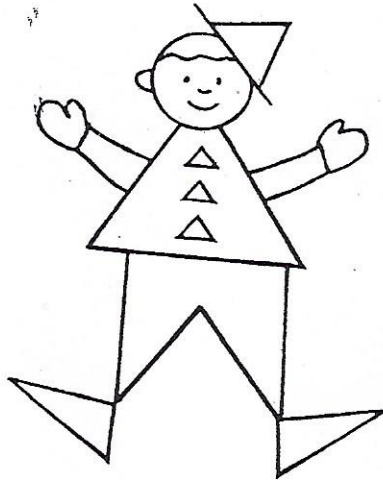
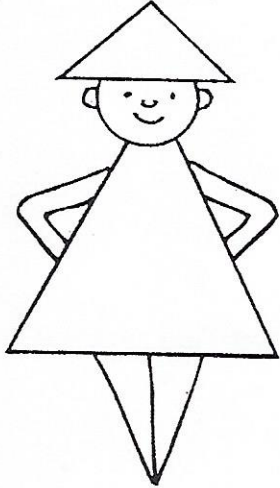



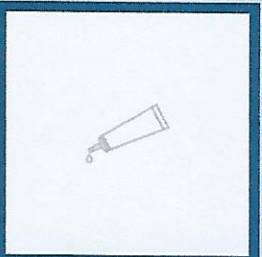
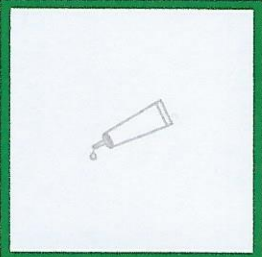

### Dreieck, Viereck, Kreis

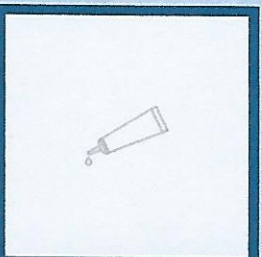
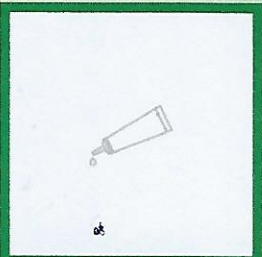
Die Kinder haben lustige Formenkostüme. Immer zwei Kinder tragen dieselbe Form als Kostüm. Finde die Paare und male die Paare mit gleicher Farbe an.

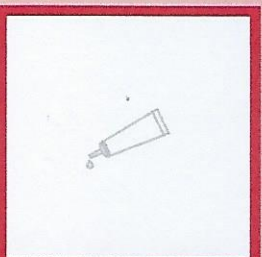
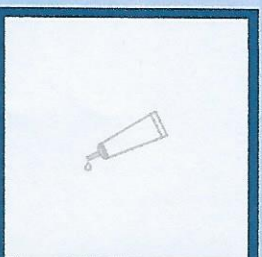
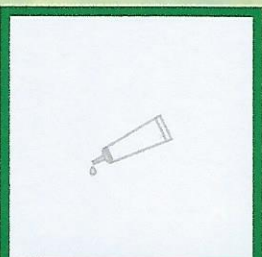

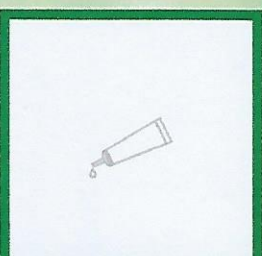

Schneide die Bilder aus, ordne sie der richtigen Jahreszeit zu und klebe sie auf.

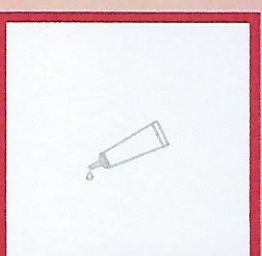
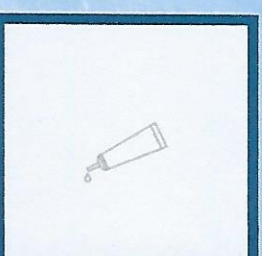
Frühling	Sommer	Herbst	Winter
			
			
			
			
			

Name: \_\_\_\_\_

Datum: \_\_\_\_\_



schwierig

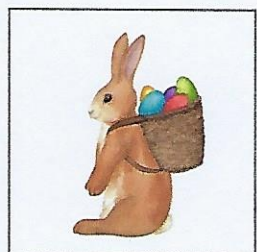
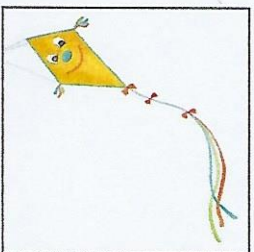
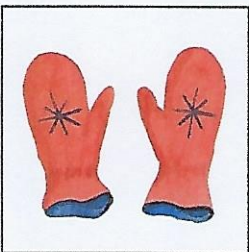
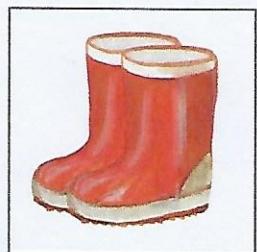
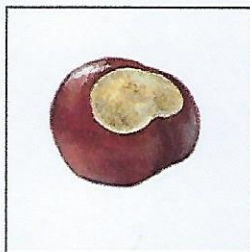
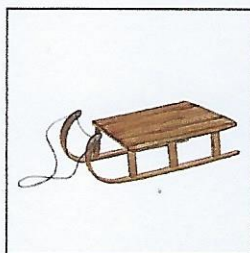
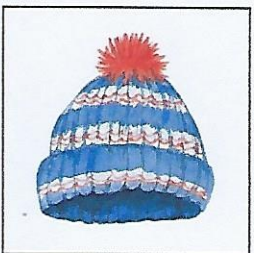
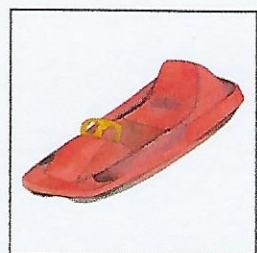
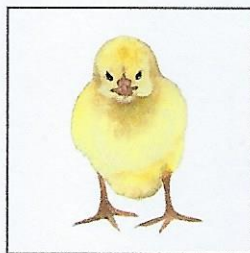
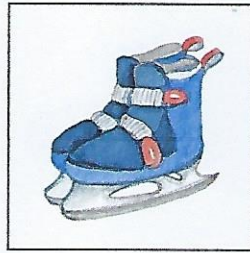
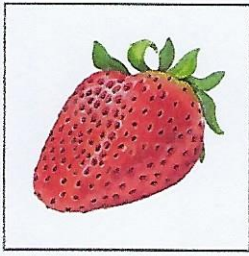



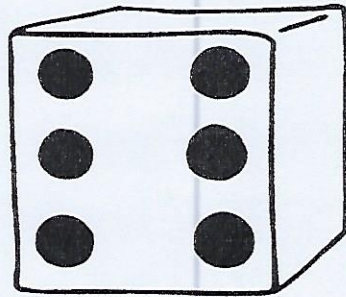
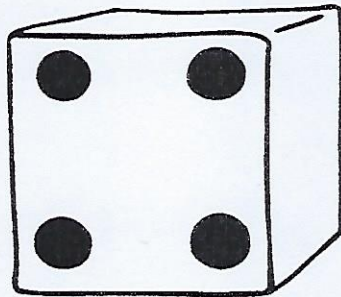
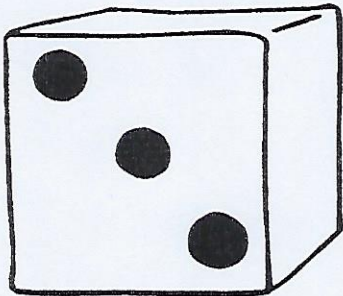
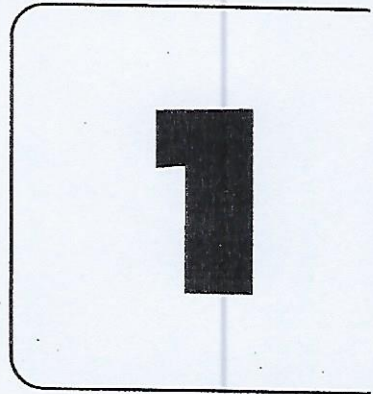
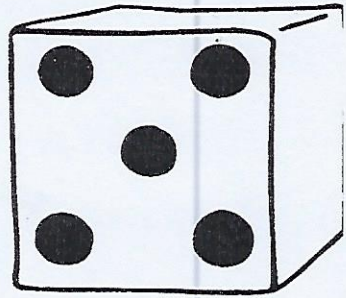
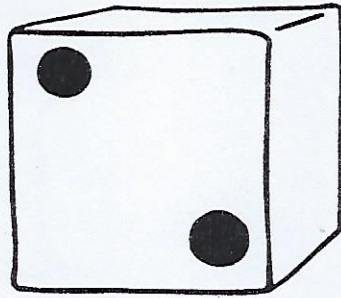
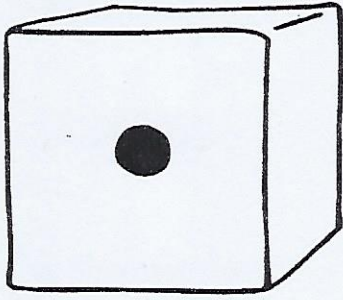

---

Was gehört zusammen?  
Verbinde jeden Würfel mit der richtigen Zahl.



Name: \_\_\_\_\_

Datum: \_\_\_\_\_

# Winterbilder ergänzen

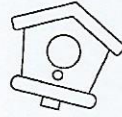

Zeichne die zweite Hälfte!

Male die Bilder bunt an!

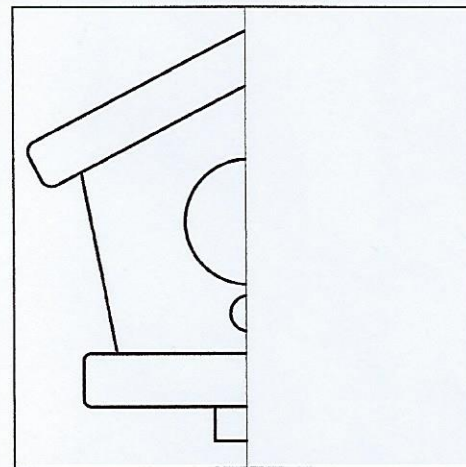
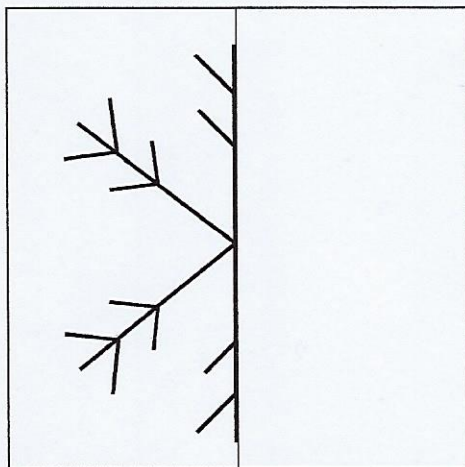
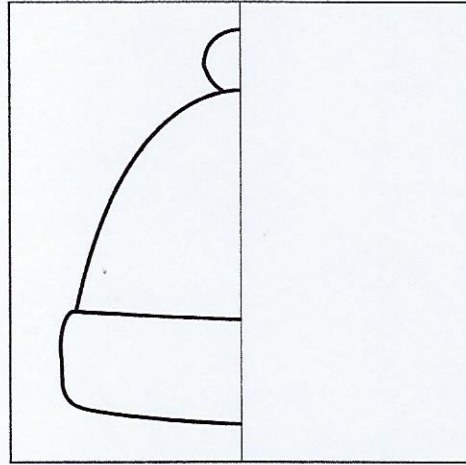
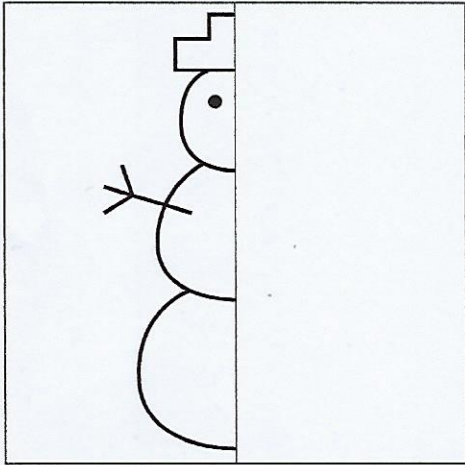
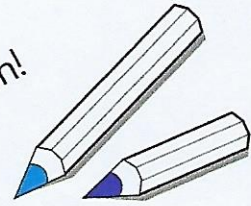

© www.kigaportal.com

Name: \_\_\_\_\_

Datum: \_\_\_\_\_

## Am Vogelhaus



Spure nach!

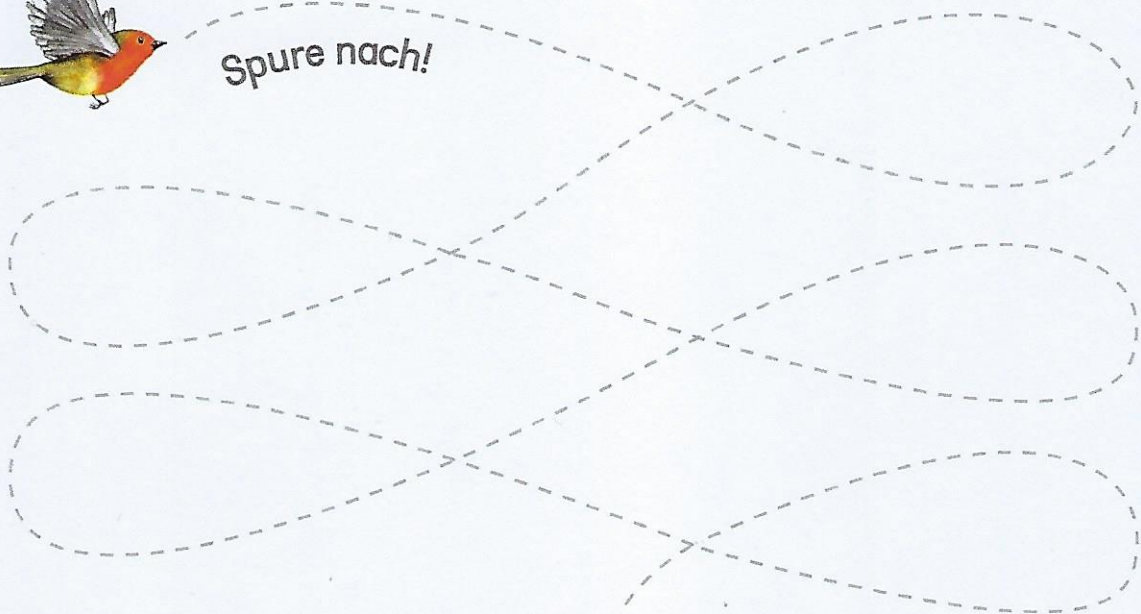

Spure nach!



© www.kigaportal.com



Schwungübungen 4

NAME \_\_\_\_\_

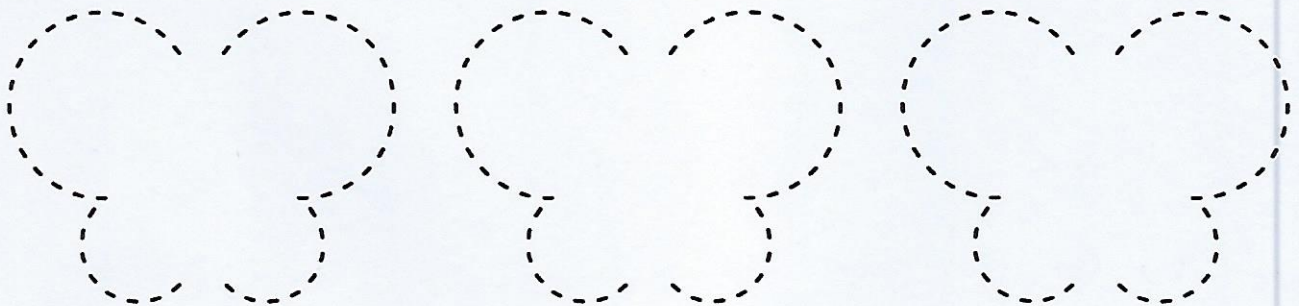
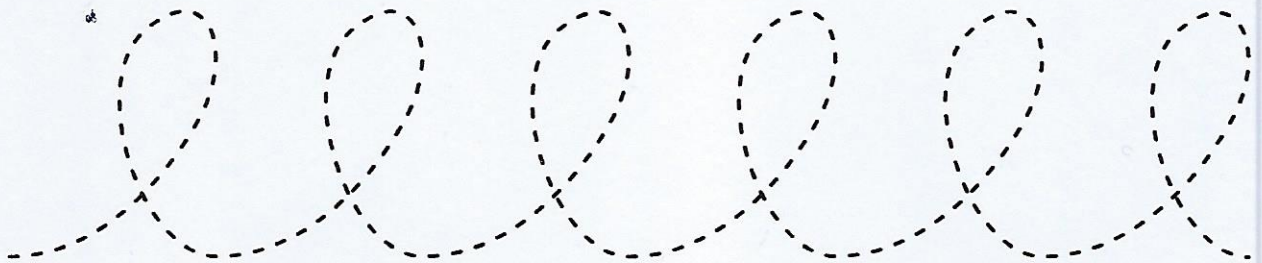
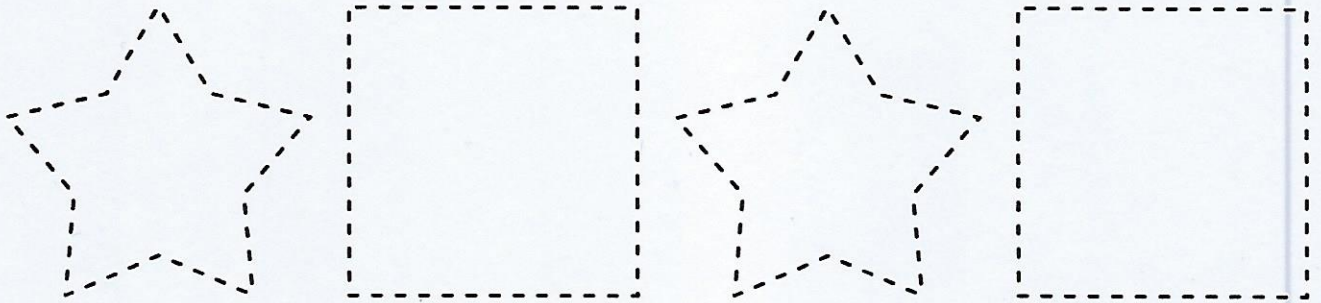
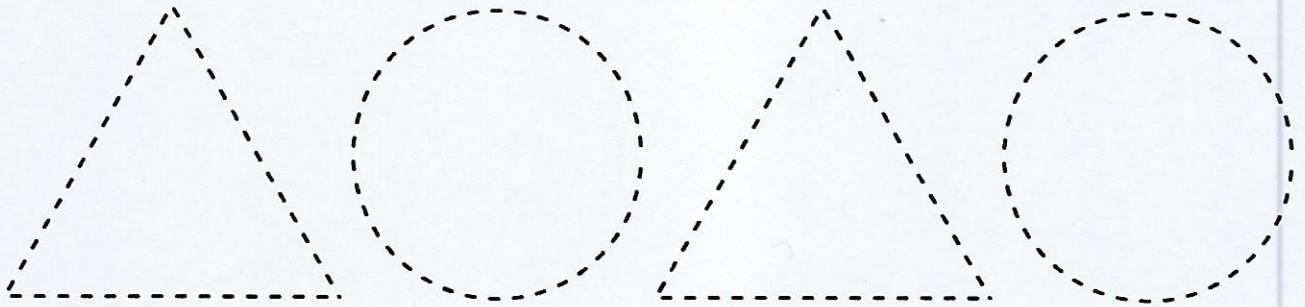

Wir verkleiden uns  
&  
Wo wohne ich? Spure die Wege nach.

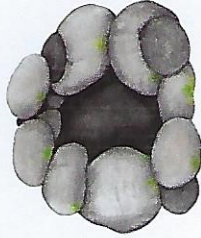
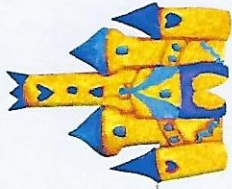

© www.kigaportal.com



Willst du wissen, wer welchen Luftballon festhält? Dann zieh mit einem Stift die Schnüre nach. Am besten nimmst du für jede Schnur eine andere Farbe. Weißt du, welche Märchen die Kinder nachspielen?

